

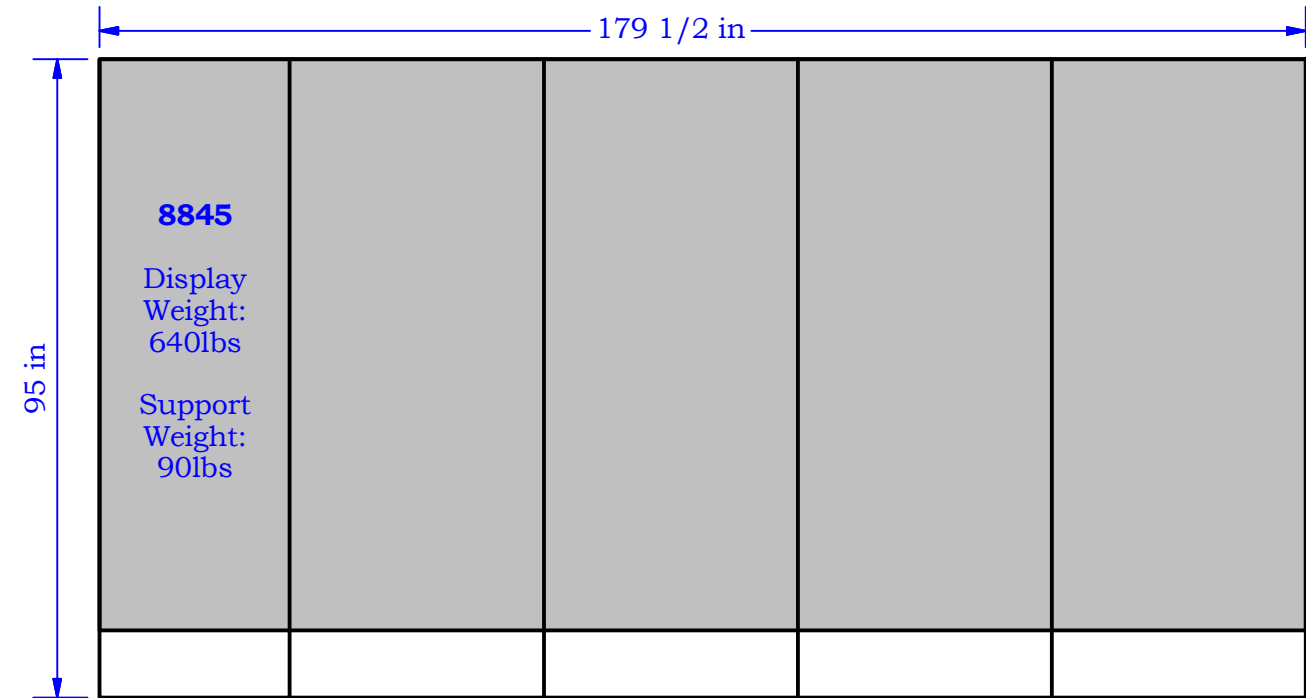

# 10mm Video Display

Rev	--
-----	----

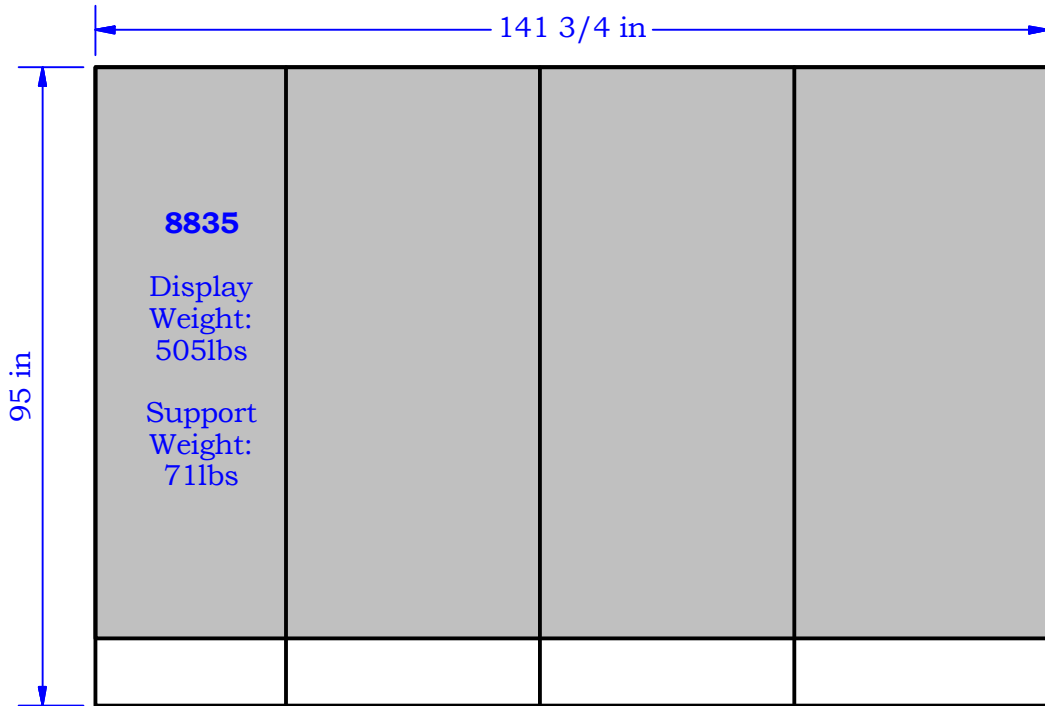
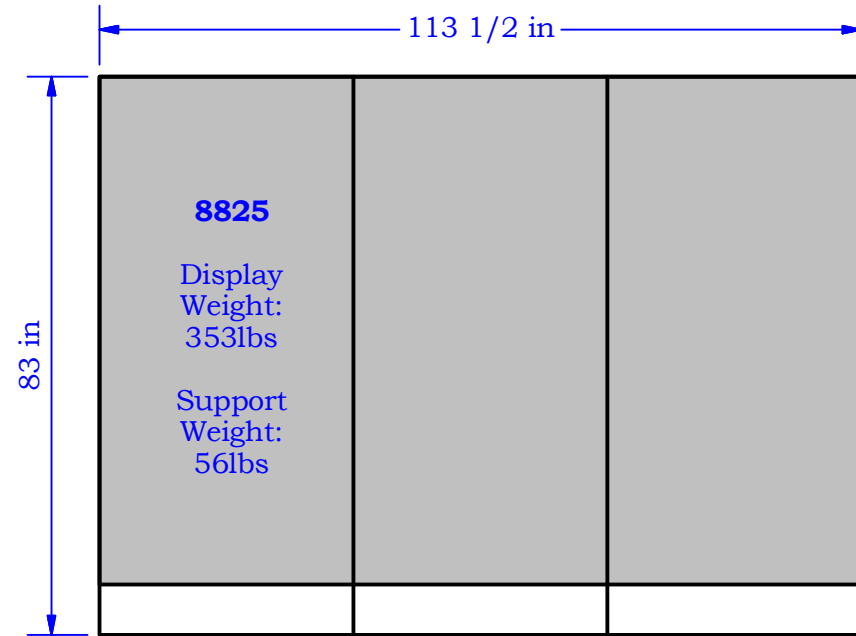
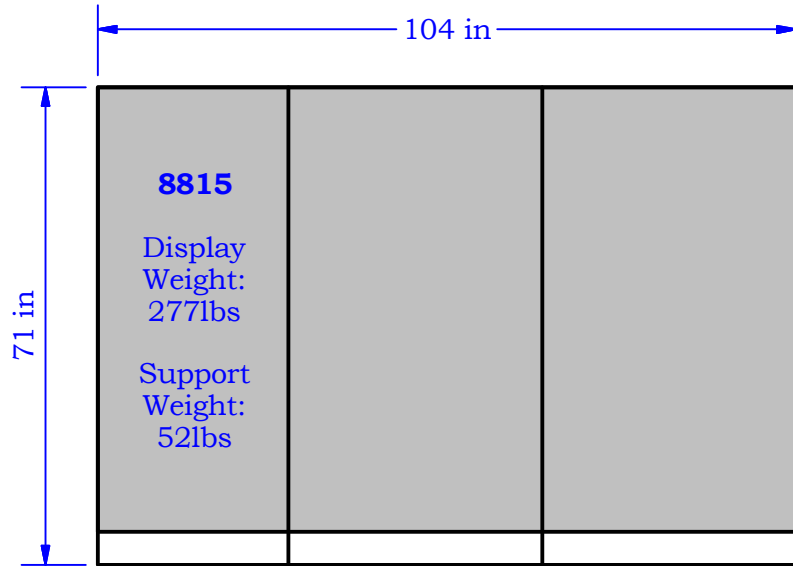

Note:  
 Anchor points shown are potential anchor positions only. All mounting points are flexible to allow attachment to mortar joints, studs, beams, etc. that may be present on the wall. Anchor types should be evaluated and selected by an engineer or architect familiar with the building's construction.

10mm Display		 <b>NEVCO</b> Nevco, Inc. Greenville, Illinois 62246	
Last ECO		Drawing No. <b>DWG-0794</b>	
Drawn <b>DDS</b>	Date <b>6/13/2016</b>	Sheet 1 of 4	

# Support Installation

Rev --

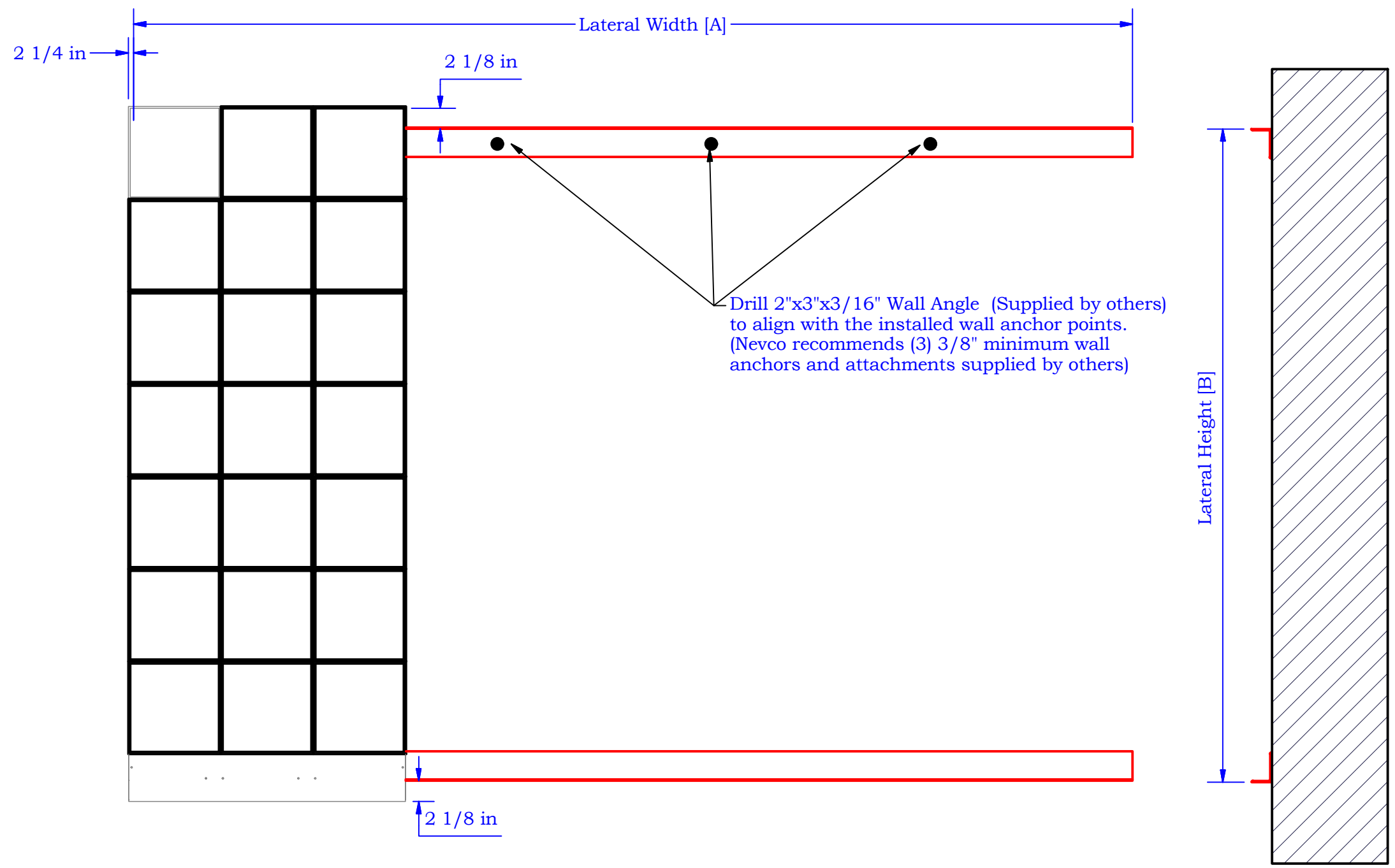

Note:  
Anchor points shown are potential anchor positions only. All mounting points are flexible to allow attachment to mortar joints, studs, beams, etc. that may be present on the wall. Anchor types should be evaluated and selected by an engineer or architect familiar with the building's construction.

Product	Description	[A]	[B]
8815	5.92' x 8.66'	99.5"	66 13/16"
8825	6.92' x 9.45'	109"	78 13/16"
8835	7.92' x 11.81'	137.5"	90 13/16"
8845	7.92' x 14.96'	175"	90 13/16"

10mm Display		 <b>Nevco, Inc.</b> Greenville, Illinois 62246	
Last ECO		Drawing No. <b>DWG-0794</b>	
Drawn <b>DDS</b>	Date <b>6/13/2016</b>	Sheet 2 of 4	

# Display Installation

Rev --

**Step 1** Attach 12" angle bracket to video cabinets with 3/8" serrated flange bolts (supplied by Nevco) to the Right, Left and Center cabinets as shown below. With the bracket in place, attach an additional bracket to back face of the mounted bracket using 2 ea. 3/8 bolt, washer, locking washer and nut (supplied by Nevco).

**Step 2** Attach Left Cabinet to Wall Angle using Drill Screws (Provided by Nevco)

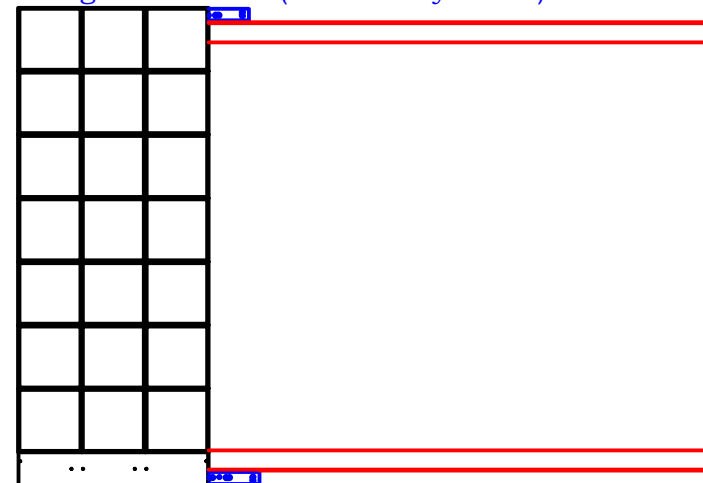

**Step 3** Attach Center Cabinets to Wall Angle using Drill Screws (Provided by Nevco)

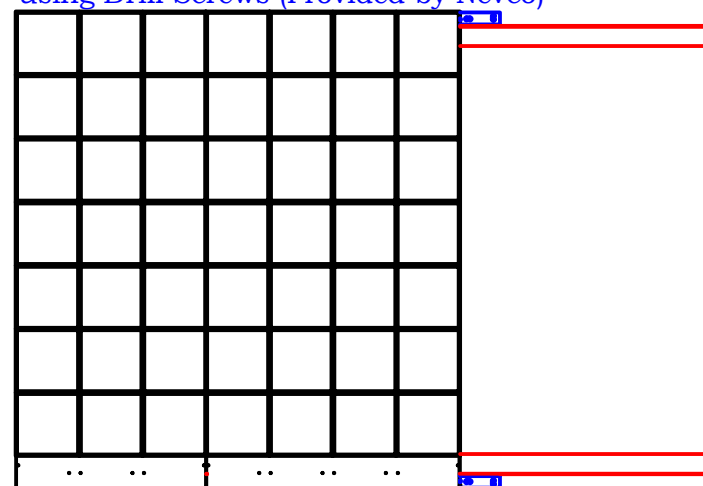

**Step 4** Attach Right Cabinet to Wall Angle using Drill Screws (Provided by Nevco)

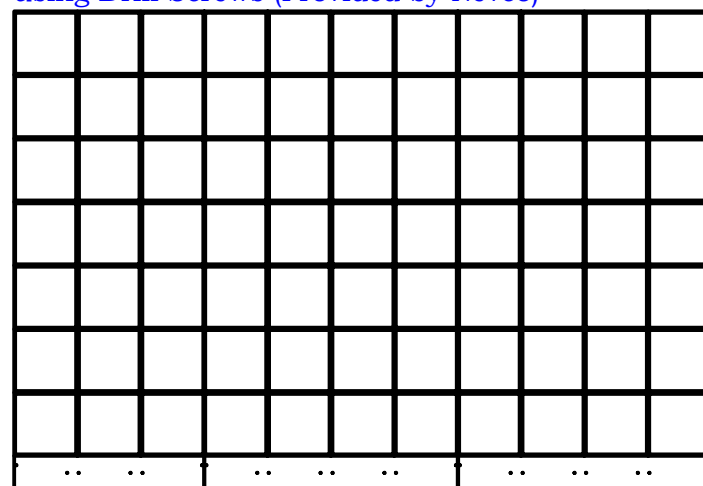

Right Cabinet

Center Cabinets

Left Cabinet

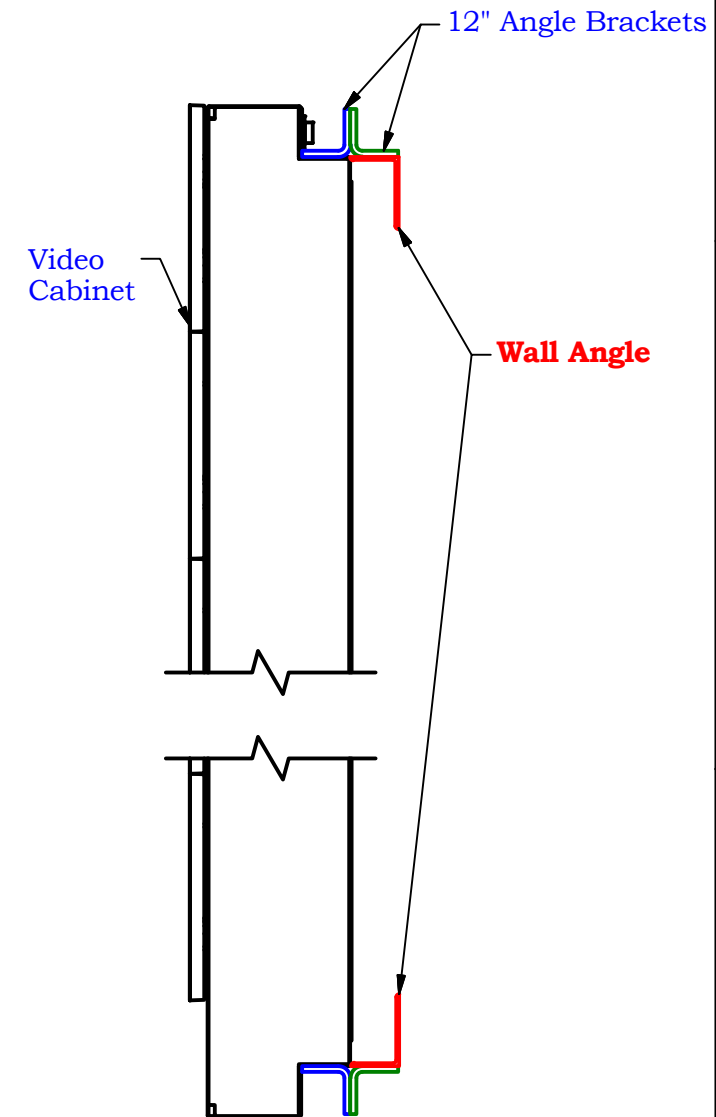
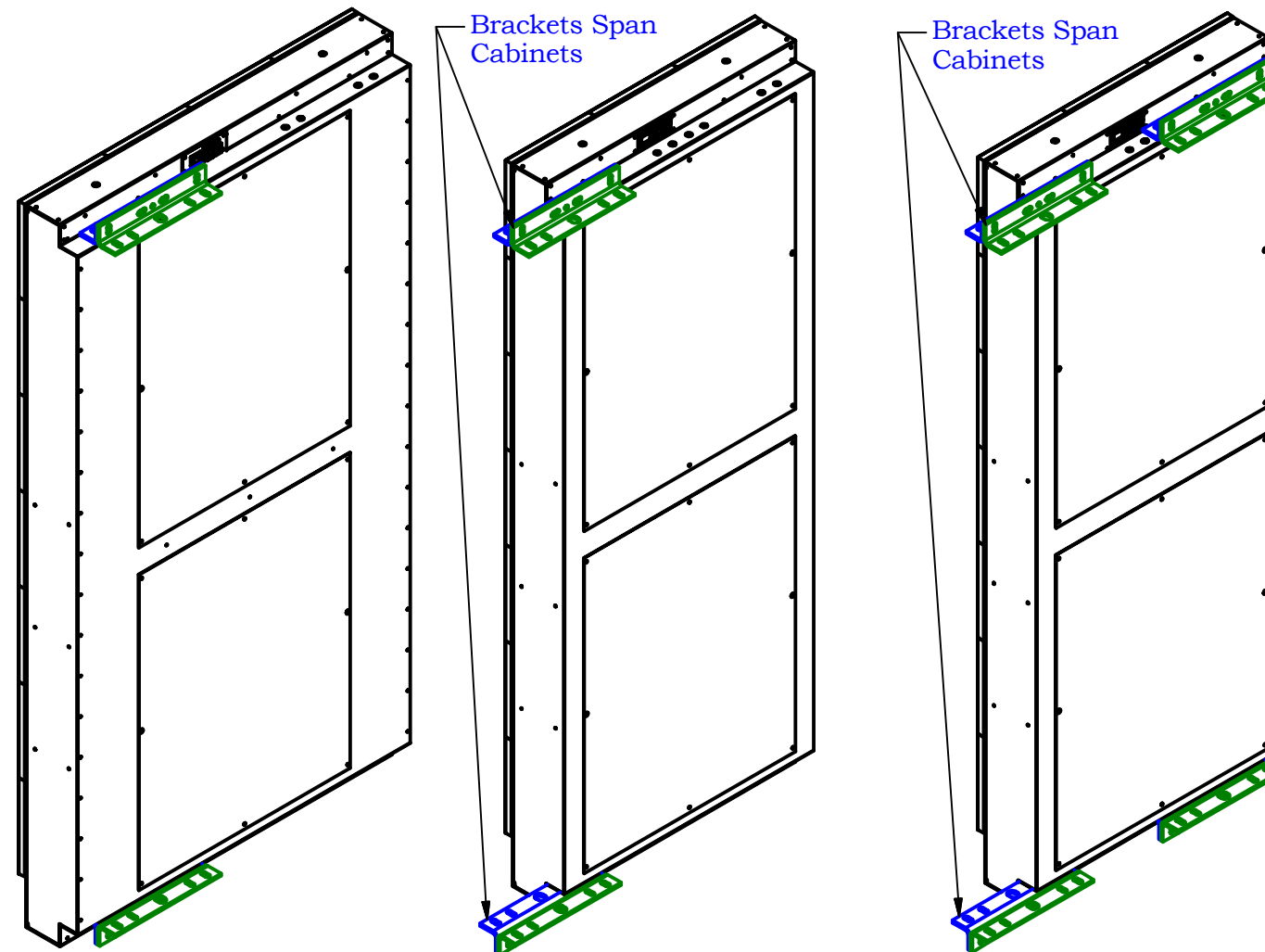

Note: If cabinets do not properly align after installation, LED panels along the center edge can be removed to bolt the cabinets together to improve alignment. This is not typically required.

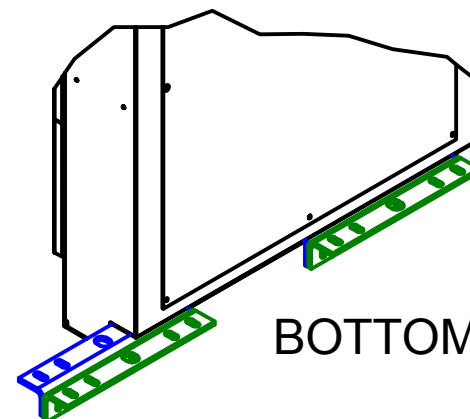

10mm Display			
		Nevco, Inc. Greenville, Illinois 62246	
Last ECO		Drawing No.	
		DWG-0794	
Drawn	DDS	Date	6/13/2016
		Sheet 3 of 4	

# Optional Single Pick Installation

## Mounting assembled video display

**Step 1:** Attach mounting brackets to top and bottom of video cabinets. Brackets will span between the cabinets. (See Page 3)

**Step 2:** Attach additional mounting brackets to the back face of the attached brackets.

**Step 3:** Attach Lifting Bar to the top of the assembled video display.

**Step 4:** Wire video display as detailed by the electrical print prior to installation.

**Step 5:** Lift display into place and use drill screws to attach video mounting brackets to installed wall angle.

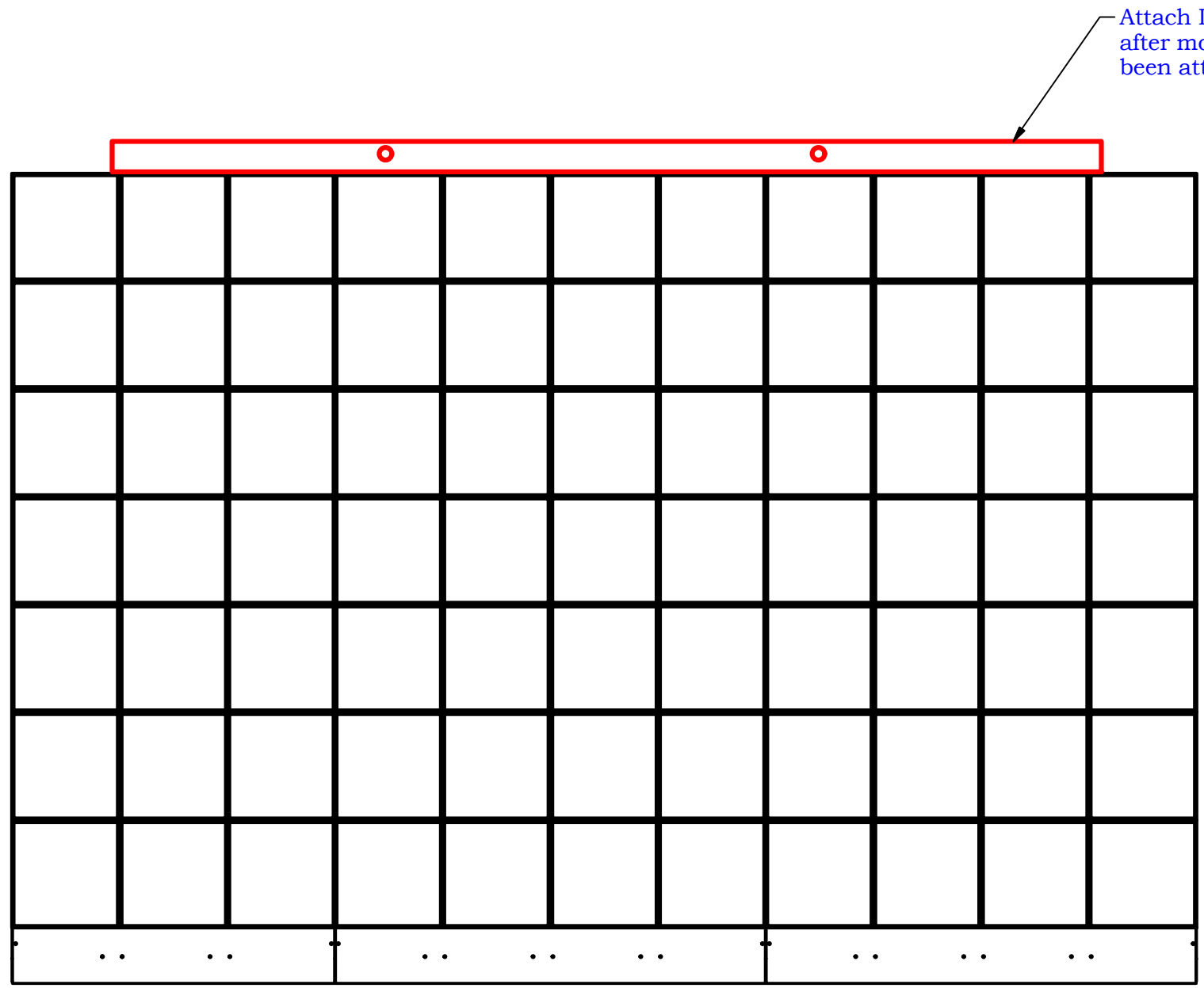
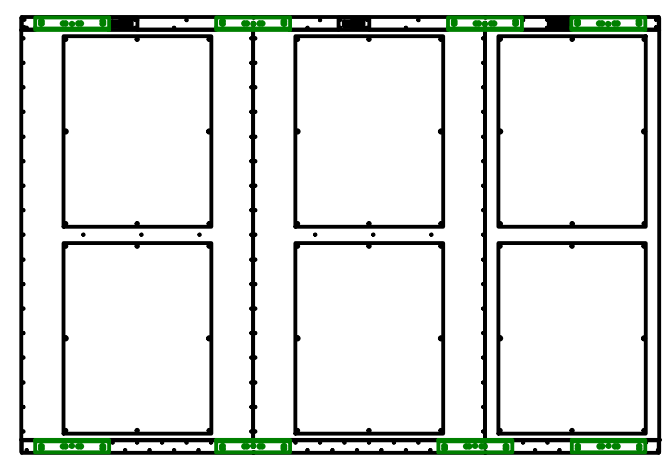

Attach Lift Bar to assembled video cabinets after mounting brackets and wiring has been attached to the display.

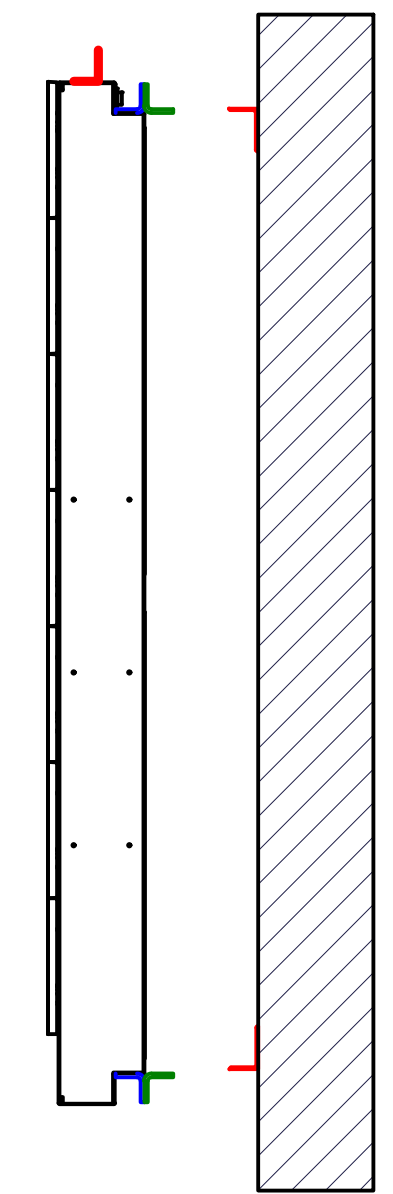

10mm Display		 <b>Nevco, Inc.</b> Greenville, Illinois 62246
Last ECO		
Drawn DDS	Date 6/13/2016	Sheet 4 of 4